



basic education

Department:
Basic Education
REPUBLIC OF SOUTH AFRICA

SENIOR CERTIFICATE EXAMINATIONS

AGRICULTURAL SCIENCES P1

2017

MARKS: 150

TIME: 2½ hours

This question paper consists of 14 pages.

INSTRUCTIONS AND INFORMATION

1. This question paper consists of TWO sections, namely SECTION A and SECTION B.
2. Answer ALL the questions in the ANSWER BOOK.
3. Start EACH question on a NEW page.
4. Number the answers correctly according to the numbering system used in this question paper.
5. You may use a non-programmable calculator.
6. Show ALL the calculations, including formulae, where applicable.
7. Write neatly and legibly.

SECTION A**QUESTION 1**

- 1.1 Various options are provided as possible answers to the following questions. Write down the question number (1.1.1–1.1.10), choose the answer and make a cross (X) over the letter (A–D) of your choice in the ANSWER BOOK.

EXAMPLE:

1.1.11

 A B C D

- 1.1.1 The breaking down of food into smaller pieces through chewing:
- A Chemical digestion
B Biological digestion
C Physical digestion
D Metabolic digestion
- 1.1.2 Soluble carbohydrates, such as starch and sugar, is an indication of ...
- A nitrogen-free extract.
B crude protein.
C ether extract.
D crude fibre.
- 1.1.3 The diagram below represents the process that assists with the digestion of food. During this process the following occurs:

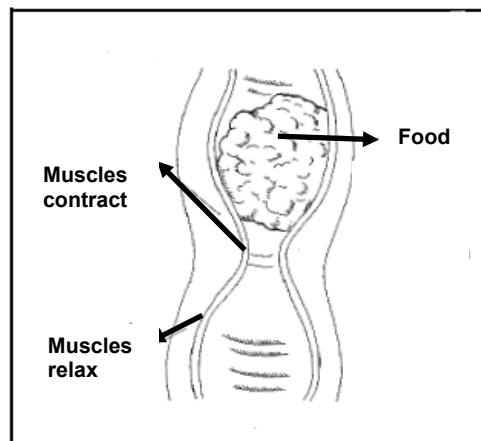

- (i) The muscle above the bolus contracts to push the food downwards.
(ii) The muscle below the bolus relaxes to move the food upwards.
(iii) If the rate of the process is reduced, the food will move slowly leading to constipation.
(iv) The muscle below the bolus relaxes to move the food downwards.

Choose the CORRECT combination:

- A (ii), (iii), and (iv)
B (i), (iii) and (iv)
C (i), (ii) and (iv)
D (i), (ii) and (iii)

- 1.1.4 The amount of feed (kg) needed by ONE animal per day is regarded as the ...
- A fodder flow unit.
 - B feed conversion ratio.
 - C feed formulation rate.
 - D fodder unit.
- 1.1.5 Which ONE of the following statements is CORRECT with regard to handling large animals, such as cattle?
- A Shouting at the animals so that they move forward.
 - B Using flapping objects to move farm animals.
 - C Directing animals towards a standing handler at the end of the crush.
 - D Do not approach animals from behind.
- 1.1.6 A/An ... injection is administered into the canal of the udder to treat mastitis.
- A intrauterine
 - B intramammary
 - C subcutaneous
 - D intravenous
- 1.1.7 The following should be considered when designing a house for pigs:
- (i) Easy access to water sprinklers for cooling
 - (ii) House to be of an appropriate size to avoid overcrowding
 - (iii) Building should be on a slight slope to allow drainage and disposal of manure
 - (iv) Building should be erected on a flat surface
- Choose the CORRECT combination:
- A (i), (iii) and (iv)
 - B (ii), (iii) and (iv)
 - C (i), (ii) and (iii)
 - D (i), (ii) and (iv)
- 1.1.8 Vaccination of farm animals helps to ... diseases.
- A eradicate
 - B treat
 - C prevent
 - D prolong

1.1.9 ONE of the following statements is NOT a disadvantage of artificial insemination:

- A Semen of superior bulls is used.
- B Undesirable traits are transferred to the offspring.
- C Testing, storage of semen and insemination are expensive.
- D Heat detection is difficult under extensive farming conditions.

1.1.10 A visible sign that a cow is about to give birth:

- A Mounting other cows.
- B Feeding on concentrates.
- C Stays with the other cows.
- D Urinates and defecates frequently. (10 x 2) (20)

1.2 Indicate whether each of the descriptions in COLUMN B applies to **A ONLY**, **B ONLY**, **BOTH A AND B** or **NONE** of the items in COLUMN A. Write **A only**, **B only**, **both A and B** or **none** next to the question number (1.2.1–1.2.5) in the ANSWER BOOK, for example 1.2.6 B only.

COLUMN A			COLUMN B
1.2.1	A:	Compound	This type of stomach in farm animals is suitable for supplementation with non-protein nitrogen
	B:	Simple	
1.2.2	A:	Selenium	Responsible for the enlargement of the thyroid gland
	B:	Cobalt	
1.2.3	A:	Endemic disease	A disease required by law to be reported when detected
	B:	Notifiable disease	
1.2.4	A:	Hay and straw	Used in pens to absorb moisture and to isolate cold cement floors
	B:	Grass and sawdust	
1.2.5	A:	Pedometer	A heat detector placed around a cow's leg to detect and record her motion
	B:	Kamar detector	

(5 x 2) (10)

1.3 Give ONE term for each of the following descriptions. Write only the term next to the question number (1.3.1 – 1.3.5) in the ANSWER BOOK.

1.3.1 The removal of gases from the rumen through the oesophagus to prevent bloating

1.3.2 A specially designed facility used to house a mothering sow enabling her to lie by the side and feed her piglets

1.3.3 The period of milk production in dairy cattle from calving to drying off

1.3.4 Washing out fertilised ova using specialised equipment

1.3.5 The volume of sperm cells in one millilitre of ejaculation (5 x 2) (10)

1.4 Change the UNDERLINED WORD(S) in each of the following statements to make them TRUE. Write only the answer next to the question number (1.4.1–1.4.5) in the ANSWER BOOK.

1.4.1 A creep feed is a ration with a high energy value that is given to farm animals for rapid growth and weight gain in preparation for the market.

1.4.2 The lowest critical temperature is the most suitable temperature for farm animals to produce.

1.4.3 The hormone responsible for the release of milk from the udder is called insulin.

1.4.4 Single births occur when more than one offspring is born from a single gestation.

1.4.5 Retention is the process when the blastocyst attaches to the wall of the uterus.

(5 x 1) (5)

TOTAL SECTION A: 45

SECTION B**QUESTION 2: ANIMAL NUTRITION**

Start this question on a NEW page.

2.1 The diagram below represents the alimentary canal of fowls.

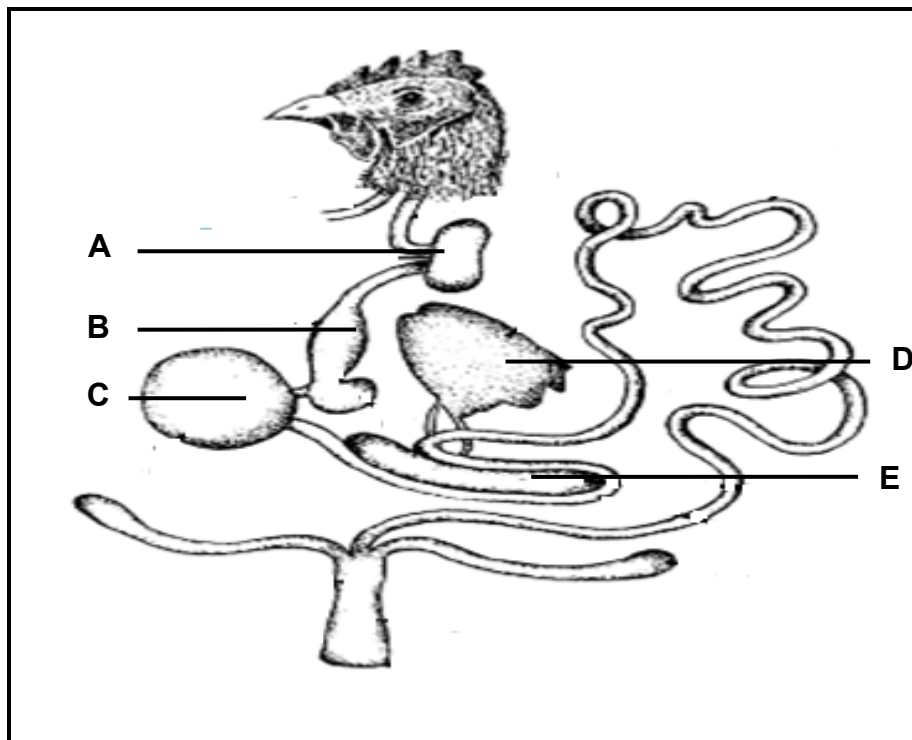

- 2.1.1 Identify the letters (**A–E**) of TWO parts representing accessory glands in the diagram above. (2)
- 2.1.2 State the functions of parts **B** and **C**. (2)
- 2.1.3 Use the diagram above and determine the structural difference between the large intestine of fowls and that of cattle. (2)

- 2.2 The diagram below is a schematic representation of the energy distribution in an animal body.

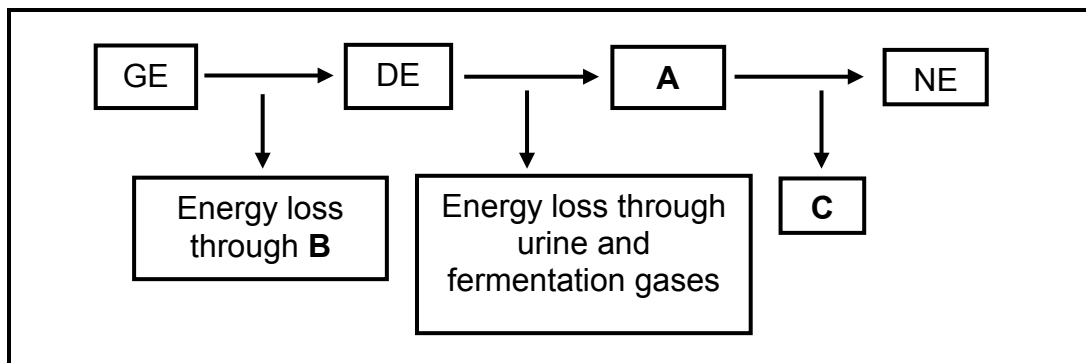

- 2.2.1 Identify **A**, **B** and **C**. (3)
- 2.2.2 What does *DE* stand for? (1)
- 2.2.3 State THREE important uses of net energy by farm animals. (3)

- 2.3 The table below provides information on a ration for sheep.

FEED COMPONENT	COMPOSITION (%)
Maize meal	35
Lucerne hay	45
Calcium phosphate	5
Salt	2
Urea	13

- 2.3.1 Identify the feed component that provides sheep with the following: (3)
- Natural protein
 - Energy
 - A cheap protein supplement
- 2.3.2 Calculate the total quantity of minerals (in percentages) that the ration above can supply to a farm animal. (3)
- 2.3.3 Give a reason why salt is included in licks. (1)

2.4 The table below indicates the composition of two feeds.

COMPONENT	FEED A	FEED B
Digestible protein (DP)	8%	12%
Carbohydrates	50%	40%
Fats	22%	5%
TDN	–	57%
NR	–	1 : 4

- 2.4.1 Use a formula to calculate the nutritive ratio (NR) of **FEED A**. (3)
- 2.4.2 Identify the **FEED (A or B)** that is most suitable for fattening cattle. (1)
- 2.4.3 Give a reason for the answer to QUESTION 2.4.2. (1)
- 2.4.4 Distinguish between a *narrow* and a *wide* nutritive ratio. (2)

2.5 The graph below represents the production of lucerne in kg DM/Ha for a period of one year.

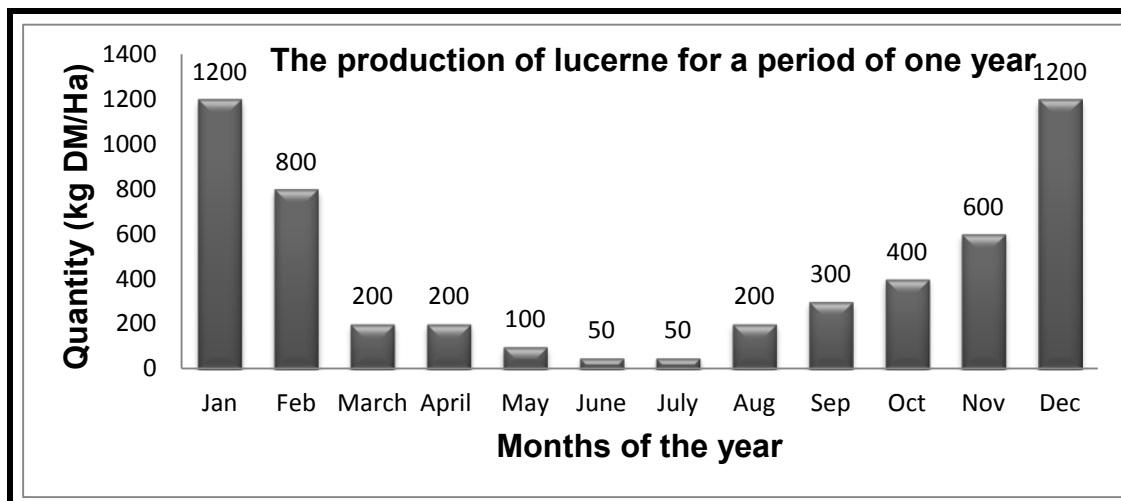

- 2.5.1 Identify the months with the lowest production of lucerne during the year in the graph above. (2)
- 2.5.2 Give a reason for the answer to QUESTION 2.5.1. (1)
- 2.5.3 Suggest TWO measures a farmer should take to address the low production identified in QUESTION 2.5.1 (2)
- 2.5.4 Calculate the lucerne production from August to December in tons. (3)

[35]

QUESTION 3: ANIMAL PRODUCTION, PROTECTION AND CONTROL

Start this question on a NEW page.

- 3.1 A farmer needs to transport weaned calves and cows to the market. The bakkie is too small to transport them all at once. The farmer can hire a contractor or the animals can be walked along the road to the market.

- 3.1.1 List THREE basic guidelines for vehicles that transport farm animals. (3)
- 3.1.2 State TWO important aspects to consider when moving farm animals on a public road. (2)
- 3.1.3 Indicate TWO guidelines to consider when moving cows with calves from one camp to another on the farm. (2)

- 3.2 The diagram below illustrates a facility used in an animal production system.

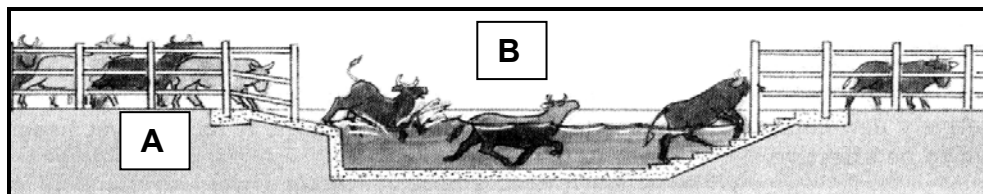

- 3.2.1 Give the reason for using the facility in structures A and B above to handle farm animals. (2)
- 3.2.2 Indicate TWO basic design features of handling facility A above. (2)
- 3.2.3 Indicate THREE effects of incorrect handling of sheep. (3)

- 3.3 The table below represents visits by pigs to the feed and water troughs at different temperatures.

VISITS TO WATER TROUGHS	VISITS TO FEED TROUGHS	TEMPERATURE (°C)
1	10	5
2	8	10
4	7	15
5	6	20
7	4	25
10	3	30
12	2	35
15	1	40

- 3.3.1 Draw a bar graph showing the number of visits to feed and water troughs at different temperatures. (6)
- 3.3.2 Indicate the trend shown in the graph in QUESTION 3.3.1. (2)
- 3.3.3 Suggest a measure the farmer can take to reduce the impact of varying temperatures. (1)

- 3.4 The picture below represents the life cycle of an internal parasite in farm animals. The parasite requires a secondary host to complete its life cycle.

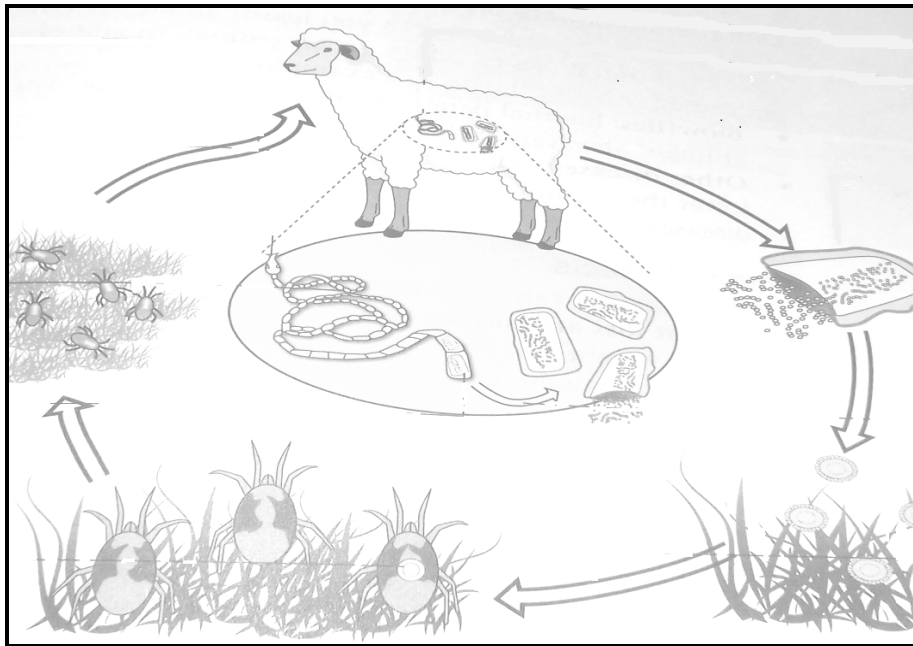

- 3.4.1 Classify the parasite represented above, according to its life cycle. (1)
- 3.4.2 Identify the TWO hosts that are needed by this parasite to complete its cycle. (2)
- 3.4.3 State THREE symptoms caused by an infestation of this parasite. (3)

3.5 Stock owners need to know what external parasites are prevalent in their own regions. They must have knowledge of the management practices to control the spread of the parasites and the serious implications thereof. Some of the management practices used by these stock owners are:

- (a) Keeping birds and fowls around the kraals and drinking points
- (b) Leaving a few ticks on animals between dipping sessions
- (c) Changing the breeding stock from exotic to indigenous

- 3.5.1 Identify the management practices used by stock owners in (a), (b) and (c) above. (3)
- 3.5.2 Indicate THREE economic implications of these parasites. (3)

[35]

QUESTION 4: ANIMAL REPRODUCTION

Start this question on a NEW page.

4.1 The diagram below represents the reproductive tract of a bull.

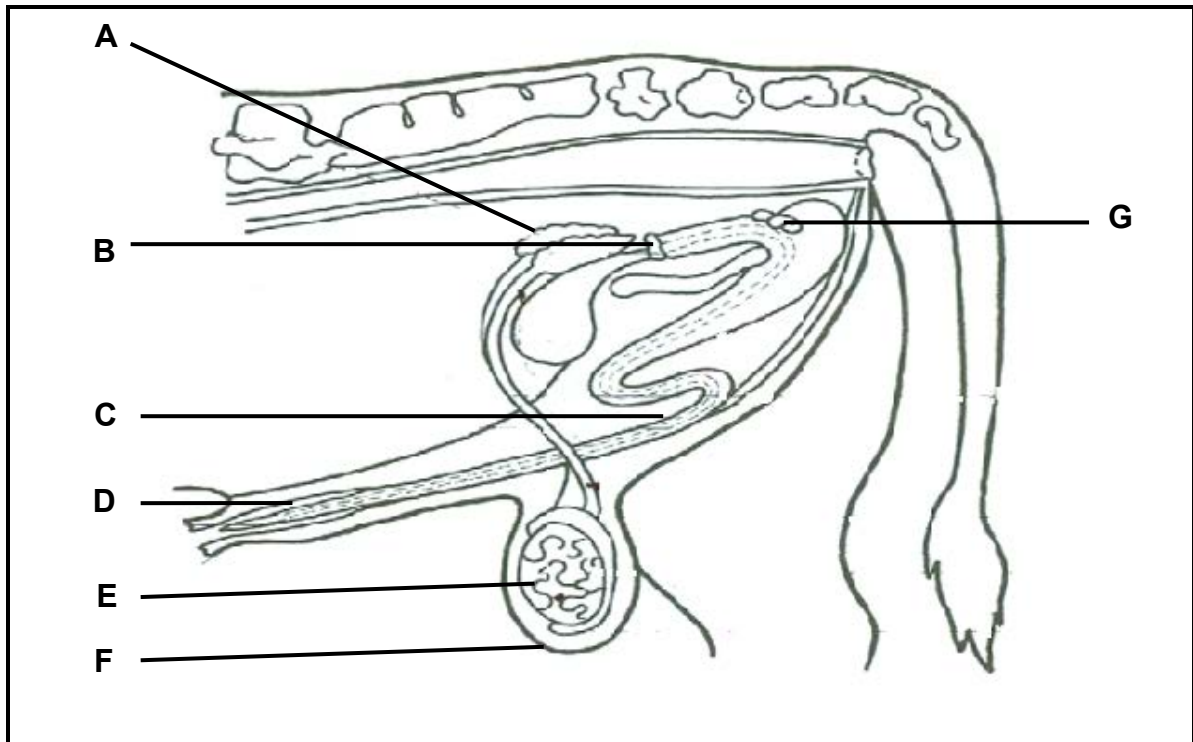

4.1.1 Identify parts **A** and **B**. (2)

4.1.2 State ONE function of part **G**. (1)

4.1.3 Indicate the role of the hormone secreted in part **E**. (1)

4.1.4 Give a reason why part **F** is located outside the body of the bull. (1)

4.1.5 Name the process used to remove part **E** in young calves. (1)

4.2 Although bulls produce semen and appear to be healthy and normal, the cow is unable to produce offspring.

4.2.1 Give a term for the condition referred to above. (1)

4.2.2 Indicate THREE causes of the condition referred to in QUESTION 4.2.1. (3)

4.2.3 Name THREE characteristics of good quality semen that can be observed under a microscope. (3)

4.3

The success of any insemination process depends on the use of clean semen, amongst other things. Stock owners need to be proactive and take the necessary steps to prevent the transmission of diseases in bulls and rams. These diseases may have serious implications, such as the loss of the entire herd, if not controlled.

- 4.3.1 Name ONE method that could be used by stock owners to detect the presence of the diseases in semen. (1)
- 4.3.2 State TWO requirements of successful artificial insemination. (2)
- 4.3.3 Equipment used during artificial insemination is described below. Give the name of EACH:
- A rectal probe with a number of linear-banded electrodes that are connected to a variable current and voltage source (1)
 - A storage container for semen at $-196\text{ }^{\circ}\text{C}$ for several years (1)
 - Polyvinyl equipment that contains and stores semen (1)
- 4.3.4 Suggest TWO disadvantages of artificial insemination in contrast with natural mating. (2)

4.4 The schematic representation below represents a reproductive process.

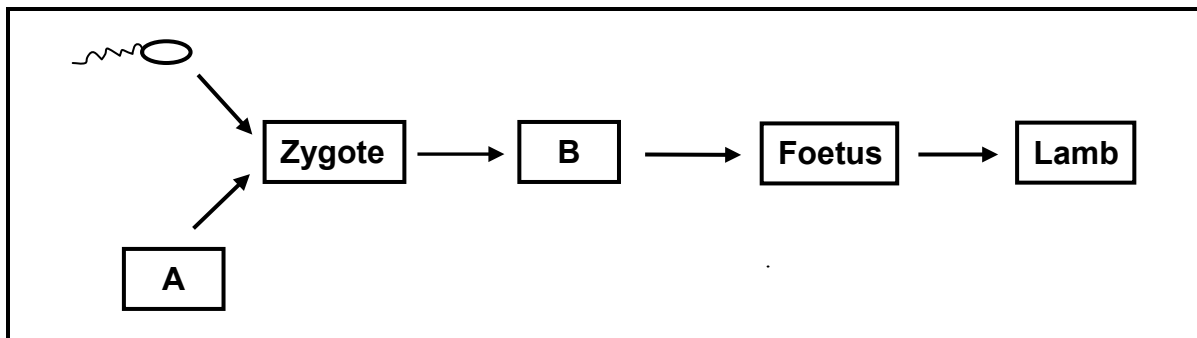

- 4.4.1 Identify **A** and **B**. (2)
- 4.4.2 Name the part in the reproductive canal of a female animal where the following may be found:
- Foetus (1)
 - Zygote (1)
 - Corpus luteum (1)
- 4.4.3 Pregnancy can be terminated at stage **B** before the end of the normal gestation period.
- Give a term used to indicate the termination of pregnancy in farm animals. (1)
 - State ONE cause of the problem referred to in QUESTION 4.4.3(a). (1)

4.5 The diagram below represents embryo transplant (ET).

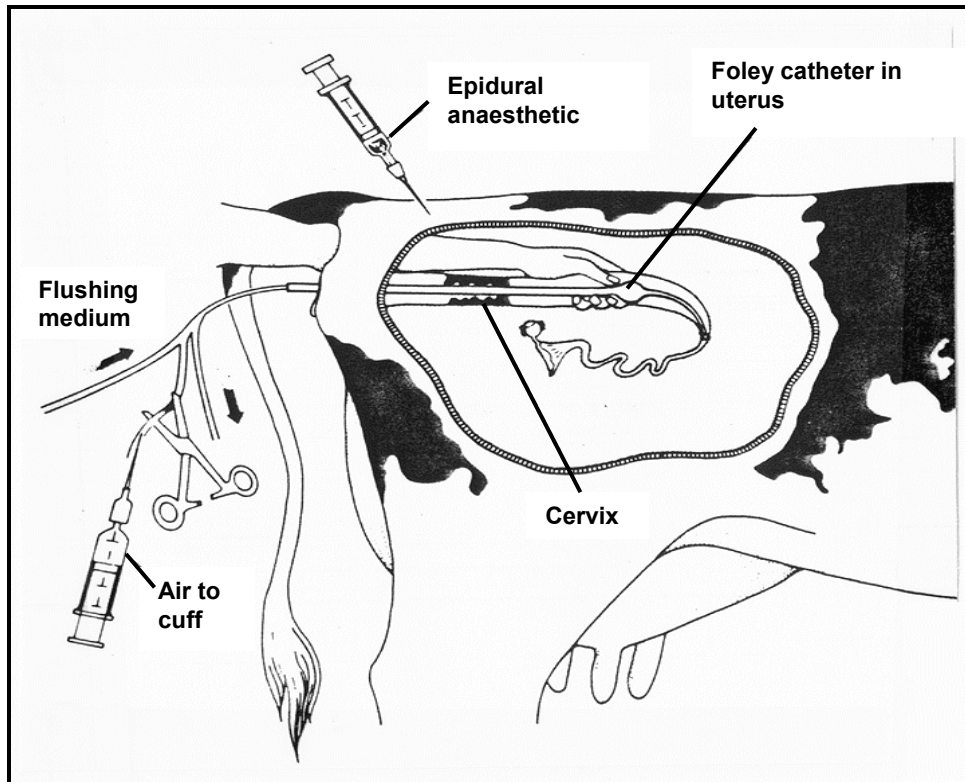

- 4.5.1 Identify the type of cow where the procedure above will be followed. (1)
- 4.5.2 Motivate the answer to QUESTION 4.5.1. (1)
- 4.5.3 Define the concept *recipient cow*. (2)
- 4.5.4 State TWO disadvantages of embryo transplants. (2)
- 4.5.5 Give the main reason for embryo transplants. (1)

[35]

TOTAL SECTION B: 105
GRAND TOTAL: 150