



basic education

Department:
Basic Education
REPUBLIC OF SOUTH AFRICA

SENIOR CERTIFICATE EXAMINATIONS

LIFE SCIENCES P1

2018

MARKS: 150

TIME: 2½ hours

This question paper consists of 16 pages.

INSTRUCTIONS AND INFORMATION

Read the following instructions carefully before answering the questions.

1. Answer ALL the questions.
2. Write ALL the answers in the ANSWER BOOK.
3. Start the answers to EACH question at the top of a NEW page.
4. Number the answers correctly according to the numbering system used in this question paper.
5. Present your answers according to the instructions of each question.
6. Do ALL drawings in pencil and label them in blue or black ink.
7. Draw diagrams, tables or flow charts only when asked to do so.
8. The diagrams in this question paper are NOT necessarily drawn to scale.
9. Do NOT use graph paper.
10. You must use a non-programmable calculator, protractor and a compass, where necessary.
11. Write neatly and legibly.

SECTION A**QUESTION 1**

1.1 Various options are provided as possible answers to the following questions. Choose the answer and write only the letter (A to D) next to the question numbers (1.1.1 to 1.1.9) in the ANSWER BOOK, e.g. 1.1.10 D.

- 1.1.1 Which part of the male reproductive system secretes testosterone?
- A Cowper's glands
 - B Prostate gland
 - C Testis
 - D Epididymis
- 1.1.2 Which ONE of the following represents the CORRECT sequence of development in humans?
- A Zygote → morula → blastocyst → foetus
 - B Morula → blastocyst → zygote → foetus
 - C Foetus → morula → blastocyst → zygote
 - D Zygote → foetus → morula → blastocyst
- 1.1.3 A function of the medulla oblongata is to ...
- A control higher thought processes.
 - B regulate blood glucose levels.
 - C regulate breathing.
 - D inhibit voluntary movement.
- 1.1.4 A disorder of the brain that is characterised by memory loss and confusion is ...
- A Alzheimer's disease.
 - B haemophilia.
 - C multiple sclerosis.
 - D Down syndrome.
- 1.1.5 Which ONE of the following is a part of the ear where grommets are inserted?
- A Oval window
 - B Semi-circular canal
 - C Tympanic membrane
 - D Pinna

1.1.6 Depth perception refers to the ability to judge distance.

An investigation was carried out to determine the effect of using one eye only or both eyes on depth perception.

Participants were asked to thread a needle as a test of depth perception. The number of attempts needed to successfully thread the needle was counted when using one eye only and then when using both eyes.

The results of the investigation are provided in the table below.

EYES USED	NUMBER OF ATTEMPTS
One eye only	12
Both eyes	2

The results of this investigation show that ...

- A binocular vision reduces depth perception.
- B using one eye only increases depth perception.
- C the number of eyes used has no effect on depth perception.
- D binocular vision increases depth perception.

1.1.7 Which ONE of the following refers to a part of the nervous system that is involved in the regulation of body temperature?

- A Corpus callosum
- B Cerebellum
- C Hypothalamus
- D Spinal cord

1.1.8 A person experiences the following symptoms:

- Loses weight easily
- Is always hungry
- Never feels cold

The most likely explanation for this combination of symptoms is that the person ...

- A secretes too much growth hormone.
- B has an overactive thyroid gland.
- C is diabetic and just had an insulin injection.
- D has an underactive hypothalamus.

1.1.9 The diagram below represents a cell during the early stages of prophase I.

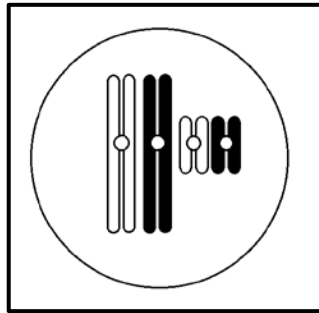

Various combinations of chromosome arrangements are given below.

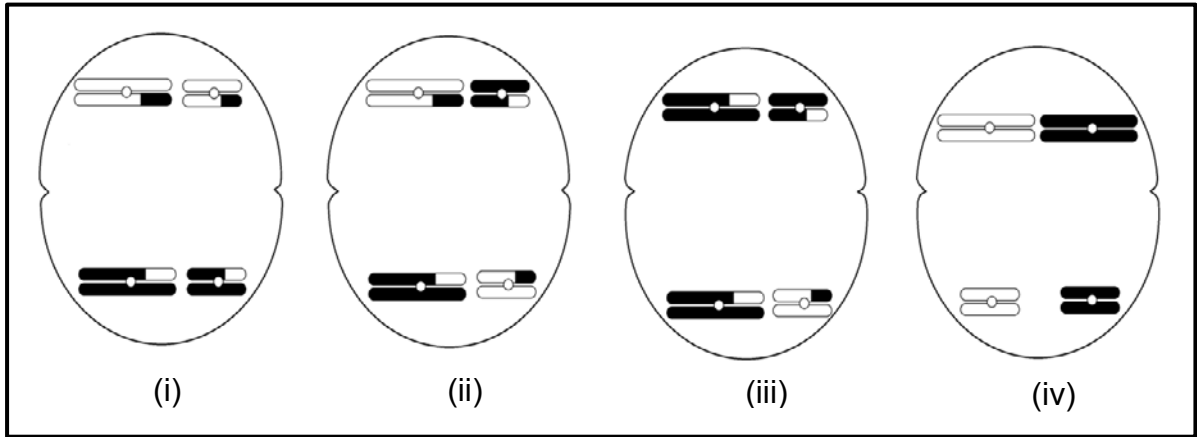

Which diagrams, (i) to (iv), are possible representations of the chromosomes at the poles of the cell during telophase I of normal meiosis?

- A (iii) and (iv) only
- B (i) and (ii) only
- C (i) and (iii) only
- D (i), (ii) and (iv) only

(9 x 2) (18)

1.2 Give the correct **biological term** for each of the following descriptions. Write only the term next to the question numbers (1.2.1 to 1.2.7) in the ANSWER BOOK.

1.2.1 The system in the body that regulates processes by secreting hormones directly into the blood

1.2.2 The farming practice of growing a crop of a single species only

1.2.3 The production of male gametes through meiosis

1.2.4 The hormone that stimulates the production of milk in a mother after the birth of a baby

1.2.5 Sharp structures found in plants for protection from herbivores

1.2.6 A measure of the total amount of carbon dioxide emissions of a person/population/company per year

1.2.7 A plant growth response to an external stimulus (7 x 1) (7)

1.3 Indicate whether each of the descriptions in COLUMN I apply to **A ONLY**, **B ONLY**, **BOTH A AND B** or **NONE** of the items in COLUMN II. Write **A only**, **B only**, **both A and B** or **none** next to the question numbers (1.3.1 to 1.3.3) in the ANSWER BOOK.

COLUMN I		COLUMN II	
1.3.1	Decreases food security	A:	Alien plant invasion
		B:	Exponential growth of the human population
1.3.2	The use of plant hormones to fight alien plant invasions	A:	Chemical control
		B:	Mechanical control
1.3.3	Hormone secreted by the pituitary gland	A:	Aldosterone
		B:	Growth hormone

(3 x 2) (6)

1.4 The diagram below represents a possible 'path' followed by an impulse when a person touches a hot plate.

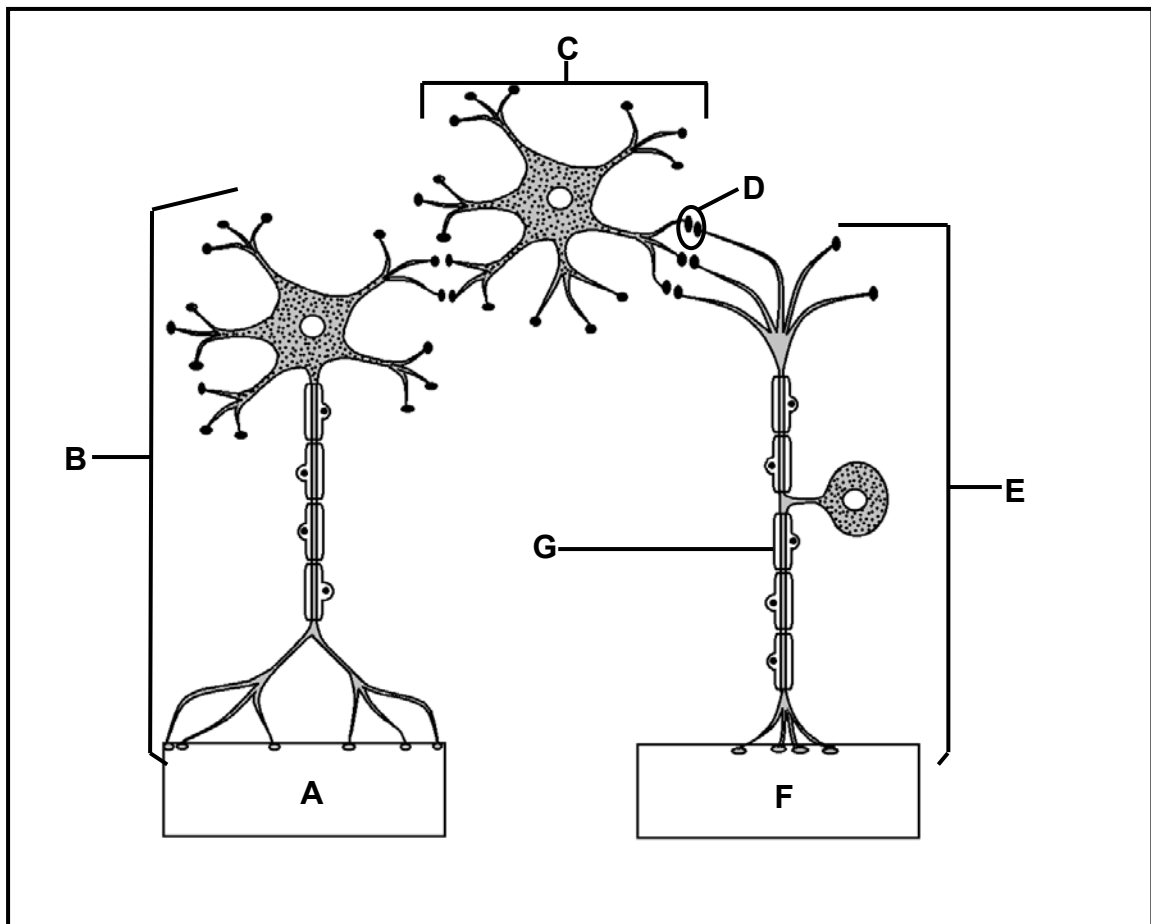

- 1.4.1 Name the 'path' represented in the diagram. (1)
- 1.4.2 Identify the type of neuron represented by:
- (a) B (1)
 - (b) C (1)
 - (c) E (1)
- 1.4.3 Give the LETTER only of the part that represents the:
- (a) Receptor (1)
 - (b) Effector (1)
- 1.4.4 Give the LETTER and NAME of the:
- (a) Region where the impulse is transmitted chemically (2)
 - (b) Part that has an insulating function (2)
- (10)**

1.5 The diagrams below represent two phases of meiosis in an organism.

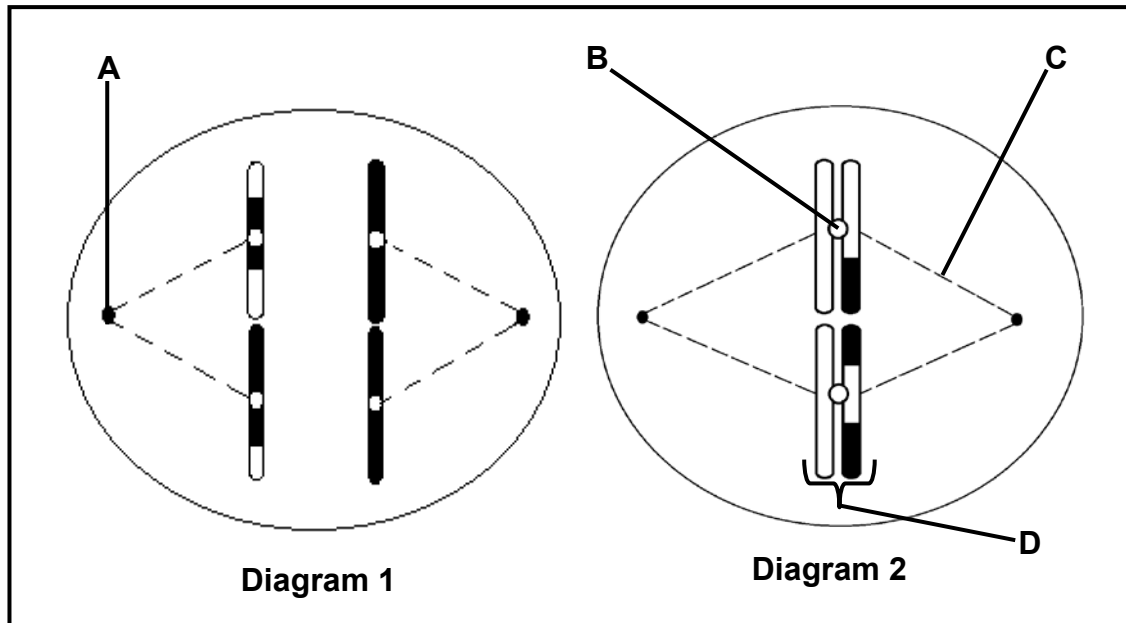

- 1.5.1 Identify the phase of meiosis represented in Diagram 1. (1)
- 1.5.2 Identify part:
- (a) **A** (1)
 - (b) **B** (1)
 - (c) **C** (1)
- 1.5.3 State what happens to structure **D** in the next phase of meiosis. (1)
- 1.5.4 Name the process during which genetic material was exchanged, as shown in the diagrams above. (1)
- 1.5.5 State the consequence if the process named in QUESTION 1.5.4 does not occur. (1)
- 1.5.6 Give the number of chromosomes present in:
- (a) The original parent cell in this organism (1)
 - (b) A human cell in the same phase as that shown in Diagram 2 (1)

TOTAL SECTION A: 50

SECTION B**QUESTION 2**

- 2.1 The graph below shows the concentration of progesterone in a woman's blood during the early stages of pregnancy.

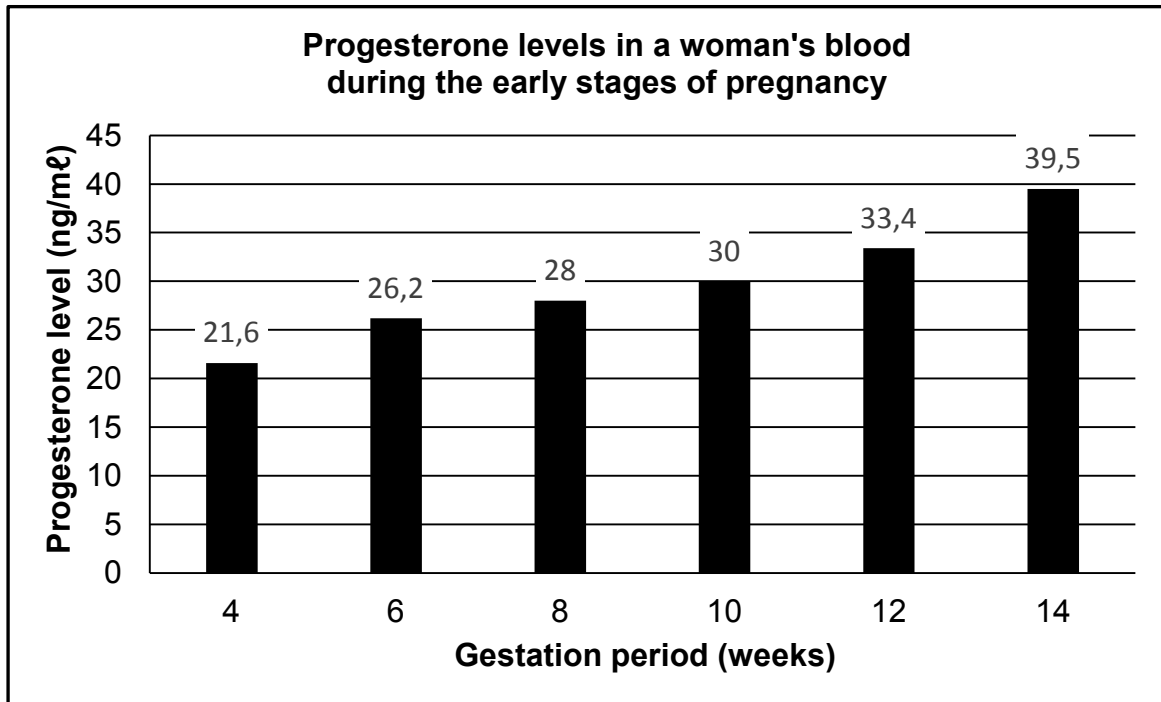

- 2.1.1 Name TWO structures responsible for producing progesterone during pregnancy. (2)
- 2.1.2 Describe the general trend in the change in progesterone levels in the woman's blood during the early stages of pregnancy. (1)
- 2.1.3 Describe the negative feedback mechanism that occurs between progesterone and FSH during pregnancy. (2)
- 2.1.4 State the importance of the negative feedback mechanism described in QUESTION 2.1.3. (1)
- 2.1.5 Calculate the percentage increase in progesterone levels between week 4 and week 14. Show ALL calculations. (3)
- 2.1.6 The woman's progesterone level in week 16 was 25 ng/ml.
- (a) Explain why this woman should be concerned about the decrease in progesterone levels. (2)
- (b) Suggest ONE way in which this problem could possibly be treated by a doctor. (1)
- (12)**

2.2 The diagram below represents the structure of a landfill site.

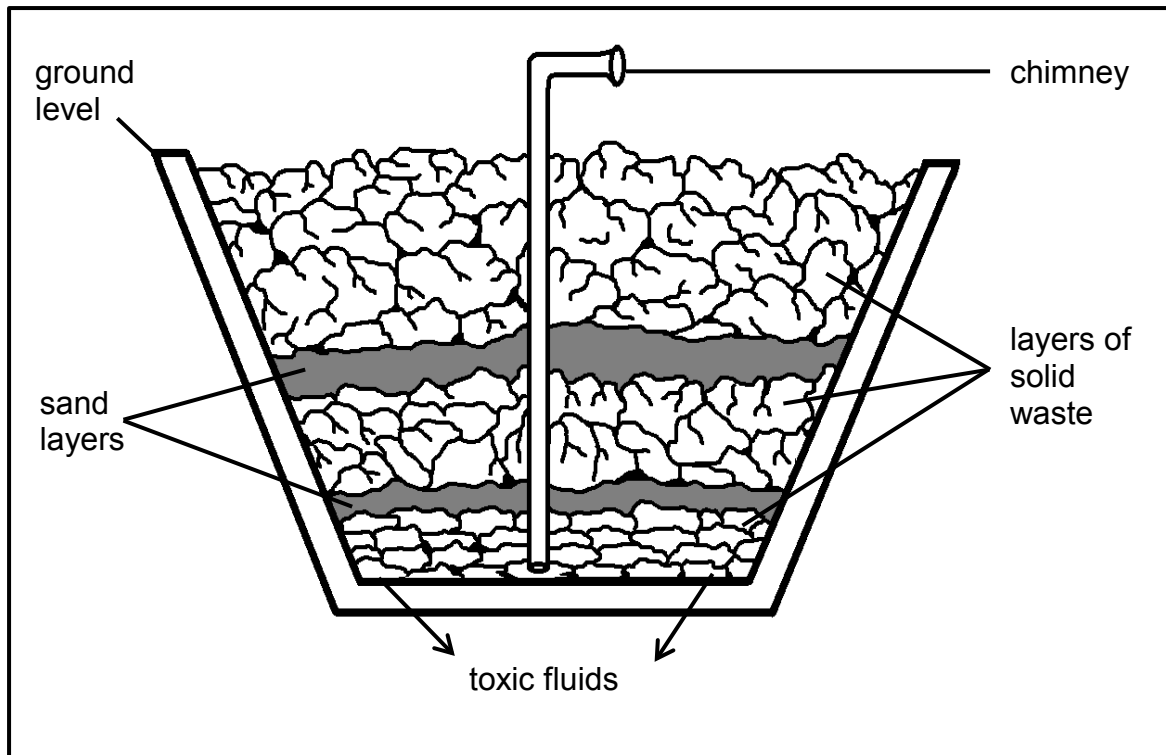

- 2.2.1 Name the flammable gas that escapes through the chimney. (1)
- 2.2.2 State ONE possible use for the gas in QUESTION 2.2.1. (1)
- 2.2.3 Give ONE reason for covering the waste with layers of sand at landfill sites at regular intervals. (1)
- 2.2.4 Give ONE visible reason why this landfill site would not be in use for much longer. (1)
- 2.2.5 State TWO ways in which the:
- (a) Landfill site could be used after rehabilitation (2)
 - (b) Amount of waste going to the landfill site could be reduced (2)
- (8)**

2.3 The diagram below represents a part of the human ear.

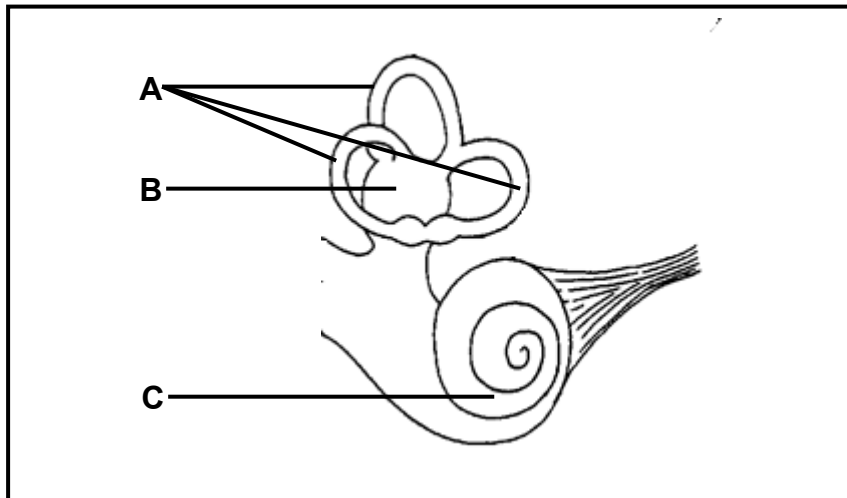

2.3.1 Name the part of the brain that receives impulses from:

(a) Parts **A** and **B** (1)

(b) Part **C** (1)

2.3.2 Name the receptor found in part **C**. (1)

2.3.3 Explain TWO ways in which part **A** in the diagram is structurally suited to maintain balance. (4)
(7)

2.4 The diagram below shows the structure of the human eye.

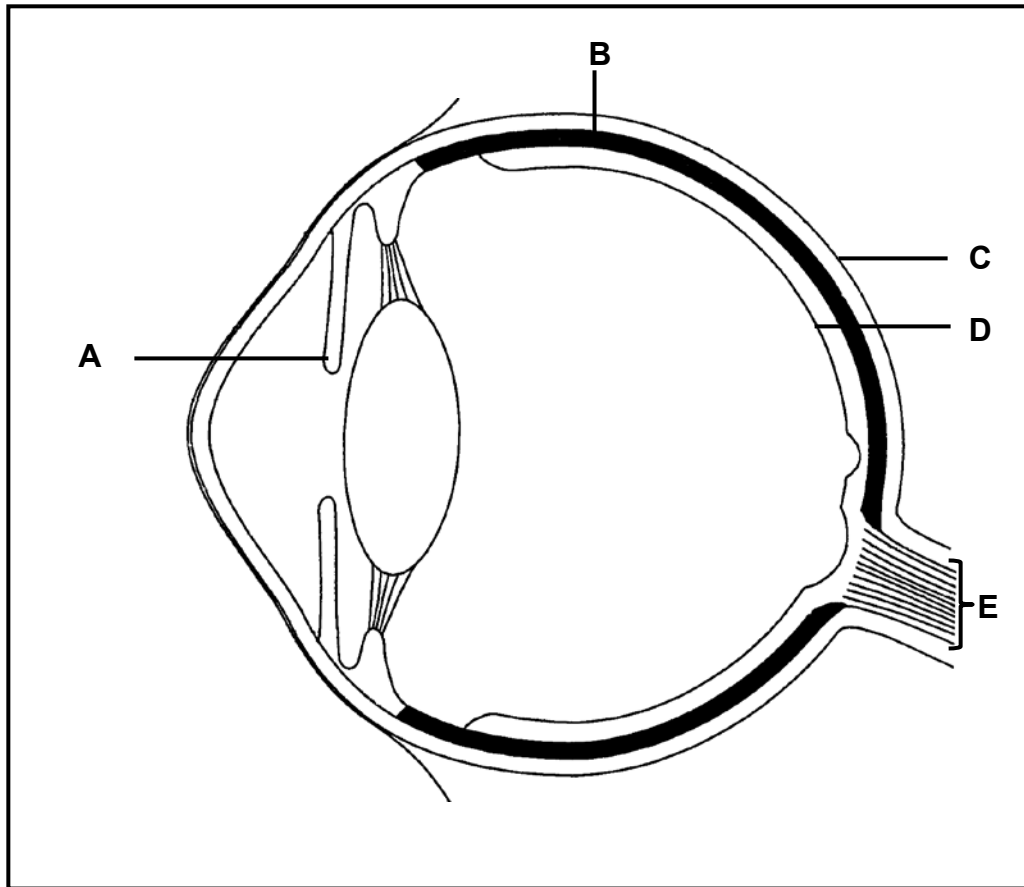

2.4.1 Identify part:

- (a) **B** (1)
- (b) **C** (1)

2.4.2 Explain the effect on a person's vision if part **E** is cut. (2)

2.4.3 Part **D** can be damaged by very bright light.

Describe how part **A** helps to protect part **D** in very bright light. (4)

2.4.4 In a condition called presbyopia, lenses lose their elasticity and therefore maintain a constant flat shape.

(a) Explain how this condition would affect a person's vision. (4)

(b) Suggest the shape of the lens that may be prescribed by a doctor to correct this disorder. (1)

(13)
[40]

QUESTION 3

3.1 The table below gives information about the sources of marine pollution.

SOURCES OF MARINE POLLUTION	PERCENTAGE CONTRIBUTION TO POLLUTION
Sewage	30
Farm runoff	20
Air pollution	20
Marine transportation	10
Industrial waste	10
Offshore oil	5
Organic litter	5

3.1.1 Draw a bar graph to represent the percentage contribution of sewage, farm runoff, industrial waste and organic litter to marine pollution. (7)

3.1.2 Untreated sewage and organic litter sometimes flow into dams.
Describe how this pollution reduces oxygen levels in the water. (4)
(11)

3.2 The endocrine system plays a role in helping a person to cope during a dangerous situation.

3.2.1 Name the hormone that is secreted in the person's body in response to a dangerous situation. (1)

3.2.2 State THREE effects that the hormone in QUESTION 3.2.1 has on the body. (3)
(4)

3.3 Describe the homeostatic control of blood glucose levels in a person who consumed a drink with a large amount of sugar. (5)

3.4 An investigation was carried out to determine the influence of alcohol on the volume of urine produced.

12 healthy, 23-year-old males of similar height and mass participated in the investigation.

The investigation was conducted as follows:

- The men were divided into two groups of six each, Group **A** and Group **B**.
- The two groups ate the same food and did the same exercise for the 24-hour-period before testing.
- Each group was given the following to drink after the 24-hour-period:
 - Group **A**: 1 litre of alcohol-free beer (beer that does not contain alcohol)
 - Group **B**: 1 litre of alcoholic beer
- Urine was collected from each man every hour.

Assume that the volume of urine collected is equal to the volume of urine produced.

The results of the investigation are shown in the table below.

TIME OF COLLECTION	AVERAGE VOLUME OF URINE COLLECTED (mℓ)	
	GROUP A	GROUP B
After 1 hour	599	643
After 2 hours	413	504
After 3 hours	112	132

3.4.1 State:

- (a) The dependent variable in this investigation (1)
- (b) TWO planning steps the investigators had to take before the investigation could start (2)
- (c) TWO factors that need to remain constant, other than the ones already mentioned (2)
- (d) TWO steps that the investigators took to ensure the reliability of the investigation (2)

3.4.2 Based on the results, explain how the intake of alcohol influences the secretion of ADH and consequently the volume of urine that is produced by the kidneys. (4)

(11)

3.5 The diagram below shows two plants (**A** and **B**) at the start of an investigation. The plants were treated in the following ways:

- No changes were made to plant **A**.
- The apical bud of plant **B** was removed.
- Each plant was covered with a box with a single opening, as shown in the diagram, and placed in a lit room.

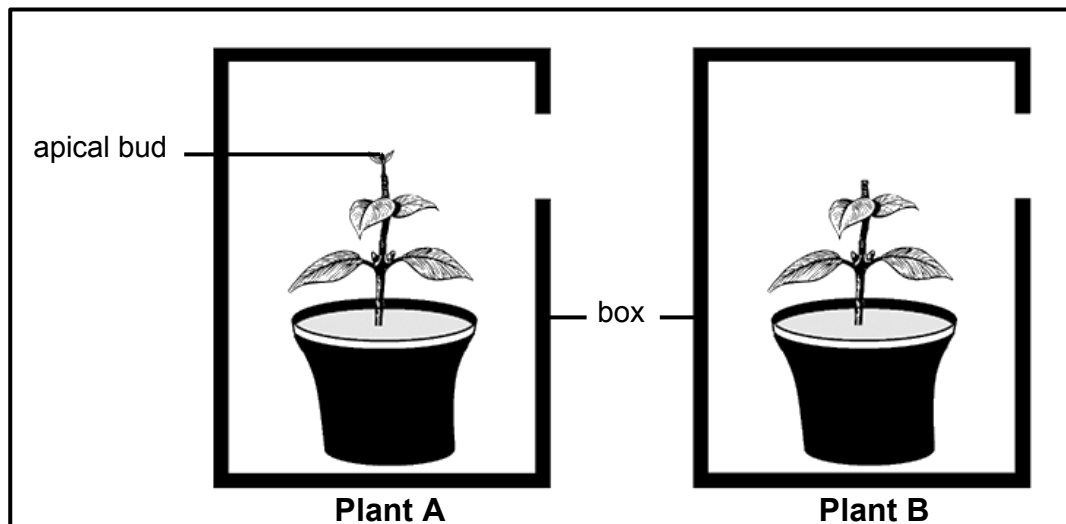

- 3.5.1 State the role of the boxes in the investigation. (1)
- 3.5.2 Name the hormone that is removed by cutting off the apical bud from plant **B**. (1)
- 3.5.3 Tabulate TWO differences between plants **A** and **B** you would expect after two weeks. (5)
- 3.5.4 The diagram below shows plant **B** seven days after being sprayed with gibberellins.

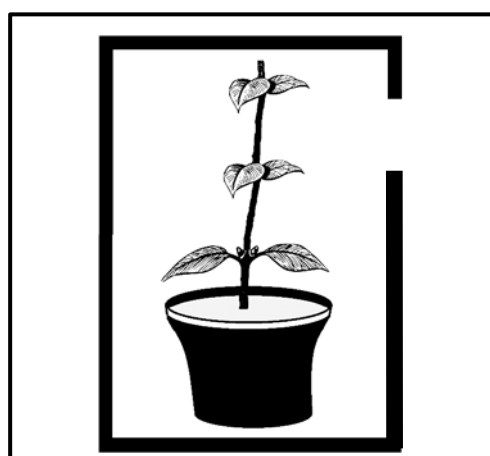

Explain the effect that the gibberellins had on the plant by referring to the changes observed in the diagram.

(2)
(9)
[40]

TOTAL SECTION B: 80

SECTION C**QUESTION 4**

Protection, nourishment and gaseous exchange are important requirements for the successful development of an embryo.

Describe how gaseous exchange and the nourishment of the embryo occur in an amniotic egg and how gaseous exchange and nourishment as well as protection of the foetus occur in humans.

Content: (17)
Synthesis: (3)

NOTE: NO marks will be awarded for answers in the form of a table, flow charts or diagrams.

TOTAL SECTION C: 20
GRAND TOTAL: 150